

#### ELECTRONSYSTEM MD TECHNICAL SHEET

Revision B of 18 February 2015

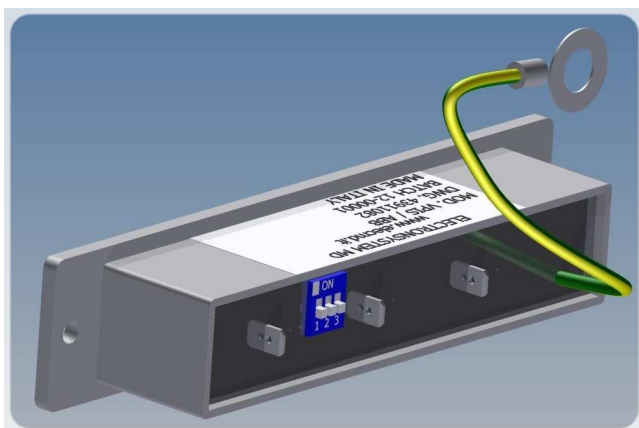
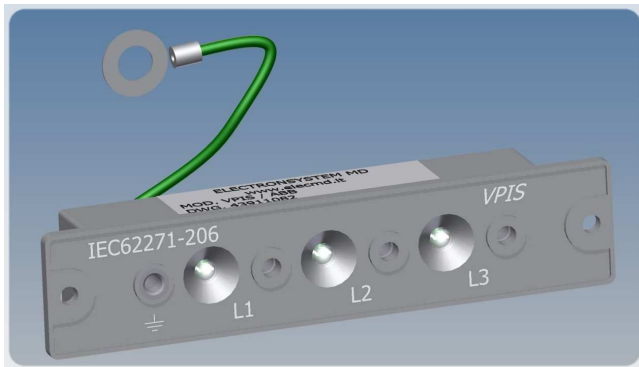
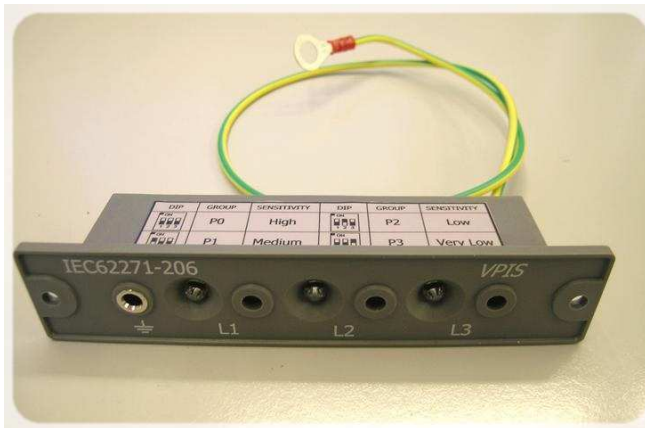

### DESCRIPTION

This capacitive voltage module is used in medium voltage switchgears. The voltage detector module is tested and manufactured according to the requirements of IEC 62271-206.

The indication of the voltage is displayed permanently with one flashing LED for each phase. The test sockets for phase comparing are nickel plated. The capacitive module has to be simply adapted to the capacitive bushing or the insulator, in which the module is used, by rear dipswitch and the selection is very easy and can be done just before shipment simplifying a lot stock management and cost.

### APPLICATIONS

- Medium Voltage Switchboards

### MAIN CHARACTERISTICS

- VPIS is a voltage presence indicating system conform to IEC62271-206 standard
- The device supplies continuously an electrical signal for phase comparison and optical blinking led for voltage indication
- Very wide and bright leds allow simple and safe visibility for personnel encharged in verification
- Dip-switch for fast and simple sensitivity adjustment allow to manage a lot of different applications with only one device reducing a lot the stock cost
- LED life time guaranteed - min. 30 years
- Suitable for panel mounting

#### ELECTRONSYSTEM MD TECHNICAL SHEET

Revision B of 18 February 2015

#### Dimension VPIS

Drawing: 43911082

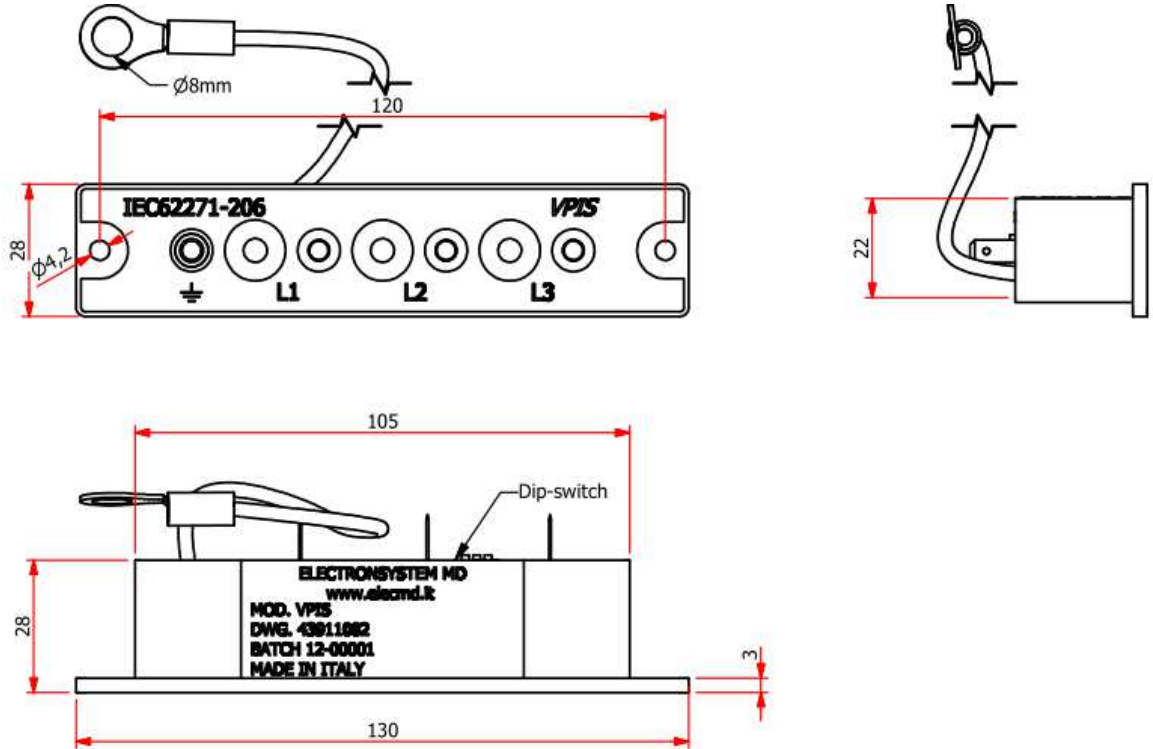

**Note:**

- Conform to IEC62271-206 standard (Old IEC EN61958)
- Internal gas tube arresters as required by standard
- Max current at connection points : 2mA
- Max voltage at connection points : 20Vca
- Suitable for medium voltage range 3.3-24 kV
- Coupling capacity range 10-40 pF
- Dip switch for sensivity selection
- Housing: grey color
- Labels: white color
- Connections: 3x faston 4.8x0.5mm
- Earthing cable: green/yellow, Lx=500mm, sec. 1mmq, eyelet Ø 8mm

DIP-SWITCH CONFIGURATION			
Setting	SW1	SW2	SW3
P0	0	0	0
P1	1	0	0
P2	0	1	0
P3	0	0	1

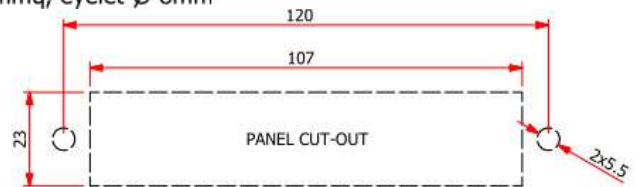

#### Electrical characteristics VPIS

Coupling capacity range	pF	From 10 to 40
Medium Voltage range	kV	From 3.3 to 24



All specs are subject to change without notice

#### ELECTRONSYSTEM MD TECHNICAL SHEET

Revision B of 18 February 2015

### COUPLING TABLE P0

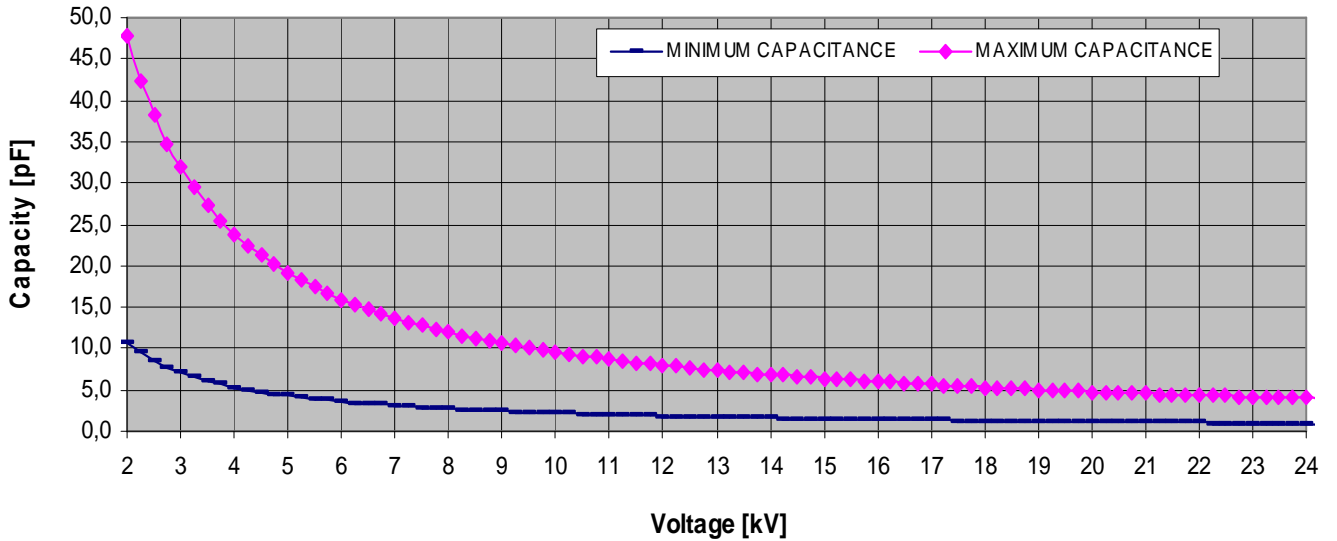

### COUPLING TABLE P1

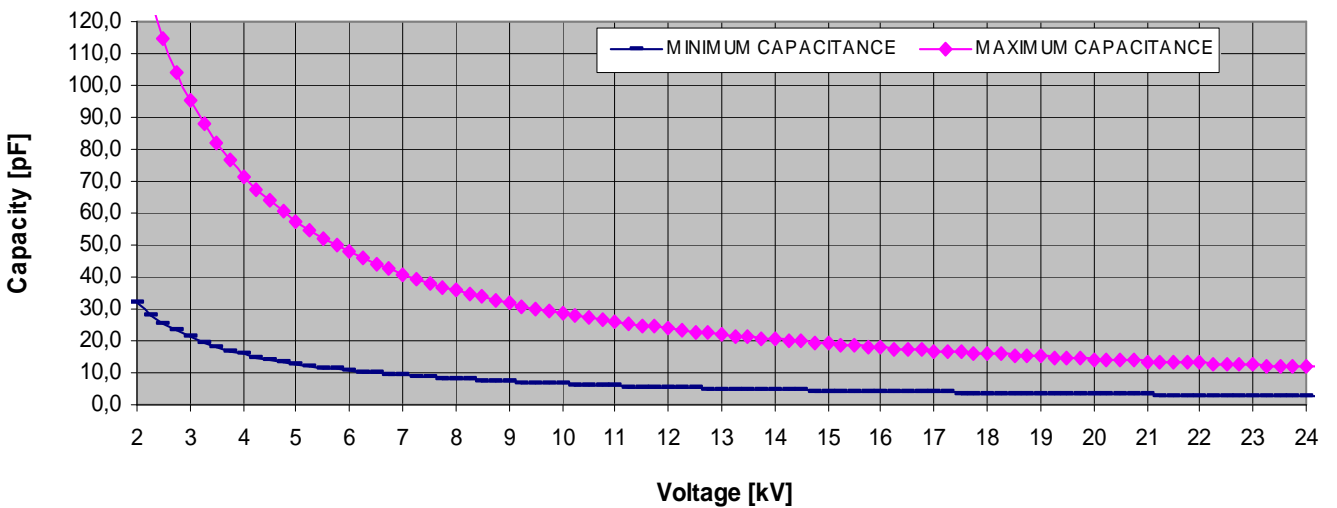

Coupling table

#### ELECTRONSYSTEM MD TECHNICAL SHEET

Revision B of 18 February 2015

### COUPLING TABLE P2

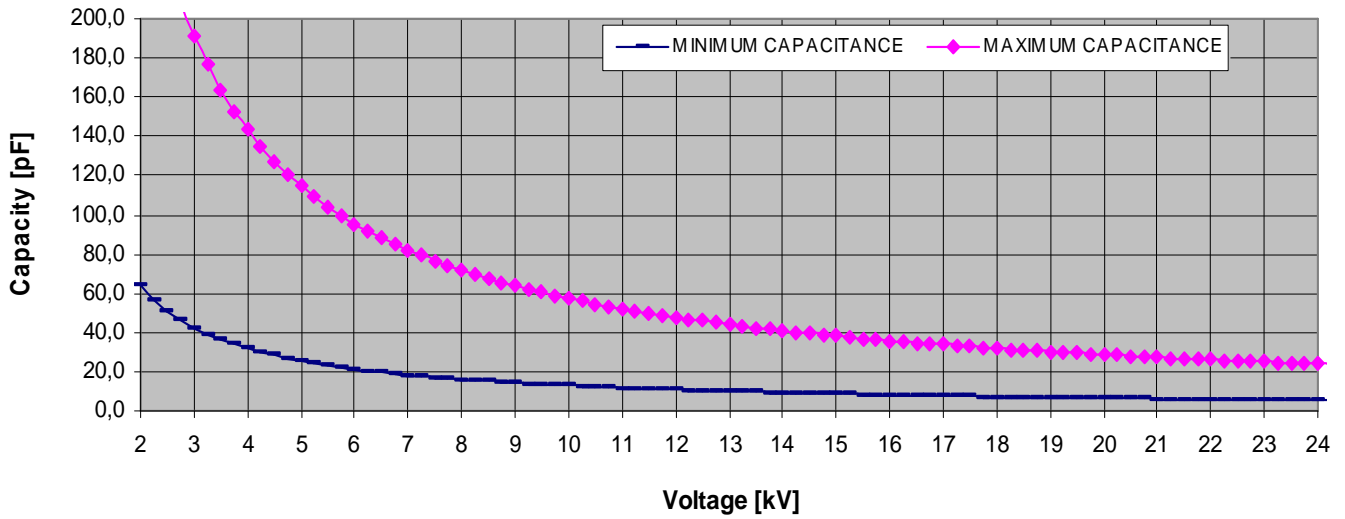

### COUPLING TABLE P3

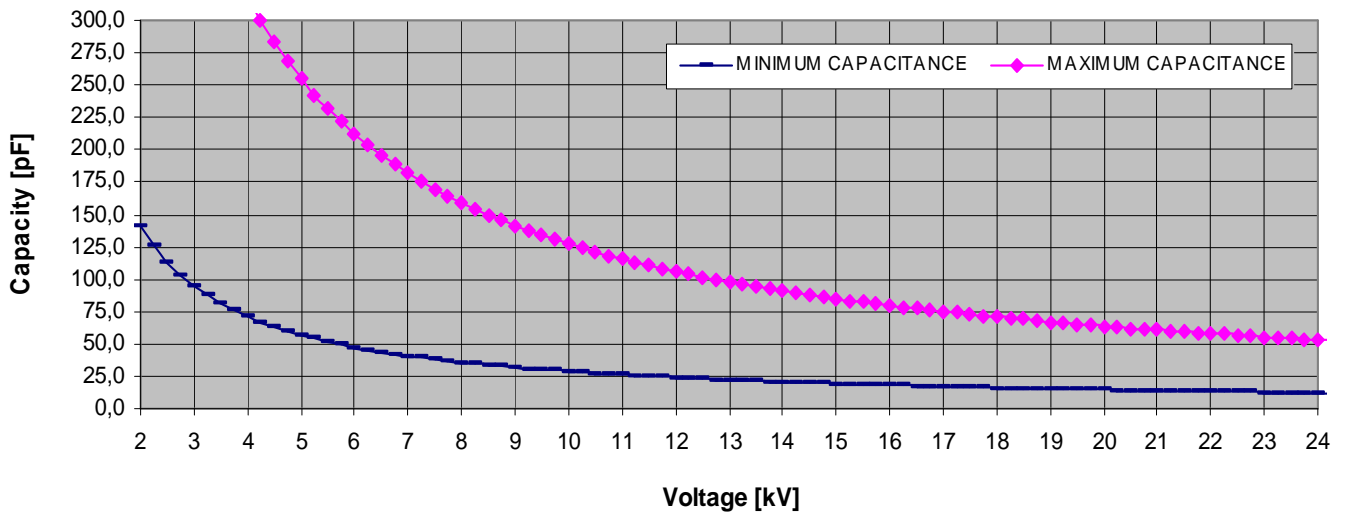

Coupling table

#### ELECTRONSYSTEM MD TECHNICAL SHEET

Revision B of 18 February 2015

#### Accessories VPIS

Coaxial cable  
Drawing: 43922293

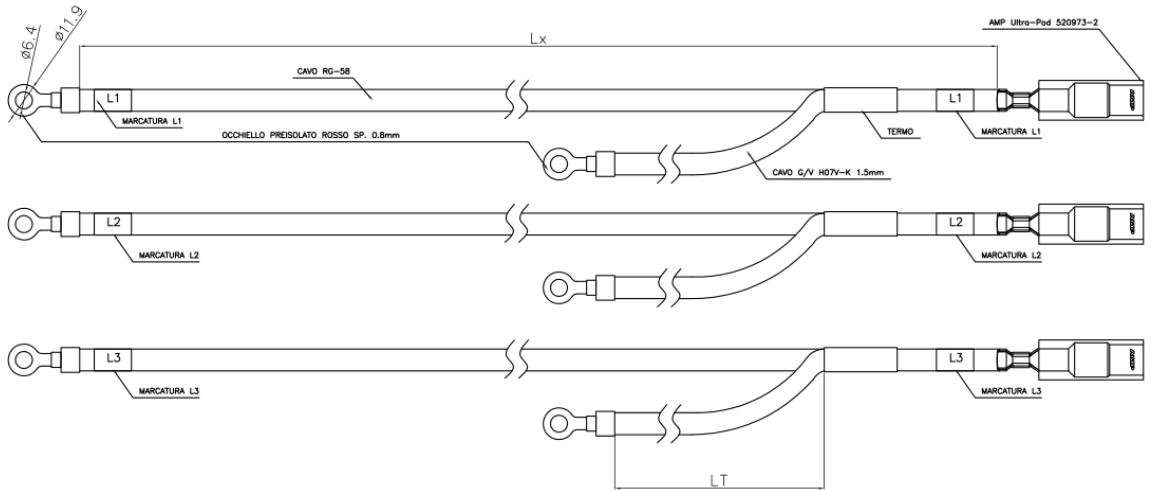

TABELLA DEFINIZIONE Lx (mm)				
	L1	L2	L3	LT
fig.1	2140	2370	2600	250
fig.2	2600	2950	3100	250
fig.3	3600	3900	4200	250
fig.4	5900	6200	6500	250
fig.5	5000	4700	4400	1000

Electronsystem MD work in partnership with its customers in designing customized executions in order to meet specific requirements, please contact us.